

Acrodisc® Syringe Filters
For Analytical Sample Preparation; Including HPLC
and Dissolution Testing

Introduction

Pall offers a broad range of analytical sample preparation products to protect your instruments and ensure the integrity of your results.

Within this Technical Guide, you'll find information relating to quality at Pall, performance studies, and useful selection criteria to help you choose the right product for your application. This Technical Guide can be used for reviewing filtration requirements and performance criteria with new lab personnel.

For further assistance, contact your local Pall technical service team www.pall.com/contact or visit our website at www.pall.com/laboratory

The technical guide is divided into several useful sections

- Pall's product quality assurance and certifications
- Why filtration is necessary
- Main considerations for choosing the best filter for your application
- Improving HPLC column life by as much as 52 times through accurate pore size ratings
- Minimizing the occurrence of extractables for less chromatographic interference
- Reducing API (active pharmaceutical ingredients) adsorption
- Product features, specifications, and a Chemical Compatibility Guide



Table of Contents

Quality Assurance and Certifications	4
ISO Certification – Quality at Pall.....	4
HPLC Certified for Low Extractables.....	4
Mass Spectrometry Certified for Low Extractables.....	4
IC Certified for Low Levels of Inorganic Extractables.....	5
Automation Certification.....	5
Manufacturing Quality Assurance.....	6
Need for Filtration	7
Solvent Reservoir/Solvent Degassing.....	7
Pump.....	9
Injector.....	9
In-line Filters and Guard Columns.....	10
Columns.....	11
Detectors.....	11
Tubing.....	11
Filter Selection	12
Filter Chemical Compatibility.....	12
Most Appropriate Effective Filtration Area (EFA).....	13
Optimal Pore Size Rating.....	14
Extending HPLC Column Life	16
Background on Column Failure.....	16
Test Methods.....	17
Test Results and Discussion.....	17
Function of Filtration to Extend HPLC Column Life.....	17
Conclusions.....	18
Extractables and Maintaining Analytical Integrity During Sample Preparation	18
What Are Extractables and Where Do They Come From?.....	18
Why Are There So Many Different Acrodisc Syringe Filter Types?.....	18
When Are Extractables a Concern?.....	19
How to Avoid Extractables' Negative Effects?.....	19
What Contributes to an Acrodisc Syringe Filter's Quality?.....	19
What Confidence Can You Have in Our HPLC Certification?.....	19
Experimental and Instrument Conditions.....	19
Pall Acrodisc One™ wwPTFE Syringe Filters.....	20
Conclusion.....	20
Suitability of Various Filters for Sample Preparation in Dissolution Testing, Based on Drug Binding	21
Experimental Determination.....	21
General Methodology.....	22
Filter Evaluation is Conducted Using the Following Methodology.....	23
Discussion.....	25
Conclusion.....	25
Features and Benefits for Pall Products	26
Product Specifications	27
Materials of Construction.....	27
Specifications.....	28
Chemical Compatibility Guide	30
References	31

Quality Assurance and Certifications

In 1974, Pall revolutionized sample preparation for analytical chemists with the development of the Acrodisc syringe filter. Today we produce high-quality filters for sample preparation and dissolution testing that meet the unique requirements of every lab we serve. Pall's microporous materials and filtration devices are manufactured under precise, highly controlled conditions. Pall's device manufacturing facilities utilize the most advanced sealing technologies, vision systems, and robotics platforms to ensure optimum lot-to-lot consistency.

Read on to learn more about our quality assurance and certifications..

ISO Certification – Quality at Pall

Quality certification to international and industry specific standards has allowed us to achieve a consistency in our processes, products and services globally. This consistency is the cornerstone to providing you with the high level of quality that you expect regardless of where you may be located.

Our manufacturing sites operate Quality Management Systems compliant with ISO 9001 and are assessed through external audits to maintain their certification to this standard. Copies of our site certificates are available at <https://www.pall.com/en/about-pall/quality.html>

Pall Corporation manufactures a wide range of filtration and separation products, including medical filters, sterilizing grade filters for aseptic processing, and laboratory filters.

HPLC Certified for Low Extractables

A filter for High Performance Liquid Chromatography (HPLC) applications is designed to increase accuracy by removing unwanted particles. However, the wrong filter can be a source of contaminants in the form of extractables that elute into the sample from the filter device. These undesired artifacts can jeopardize analytical results. Some extractable concerns include coelution, false quantitation, and extraneous peaks.

Pall specifically selects the highest grade materials and performs rigorous extraction methods on our membrane products to eliminate the occurrence of undesired artifacts.

Pall HPLC certification ensures that analytical results will not be compromised by extractable filter materials. Our membranes have been tested for compatibility with the common HPLC solvents water, methanol, and acetonitrile, using established HPLC procedures. In addition, to verify low levels of UV-detectable extractables, samples of the entire HPLC Acrodisc syringe filter line are evaluated prior to release.

Mass Spectrometry Certified for Low Extractables

To ensure low levels of extractables, Pall certifies that all lots of water wettable polytetrafluoroethylene (WWPTFE), membrane used in the Acrodisc MS syringe filters have been tested according to established LCMS techniques.

Each box of product comes with a certificate containing Total Ion Current (TIC) chromatograms that show all detected peaks relative to an Internal Standard. Results for integrity, burst, and flow rate tests are also included on the certificate.

IC Certified for Low Levels of Inorganic Extractables

Pall confirms that Ion Chromatography (IC) Acrodisc syringe filters have been tested using a highly sensitive IC protocol to monitor inorganic extractables. For IC applications, our IC Acrodisc polyethersulfone (PES) syringe filters are certified for low levels of inorganic extractables.

Actual background levels of filter extractables are typically less than 20 ppb for chloride, 6 ppb for nitrate, 1 ppb for phosphate, and 10 ppb for sulfate.

IC Certified for Low Levels of Inorganic Extractables

Pall confirms that Ion Chromatography (IC) Acrodisc syringe filters have been tested using a highly sensitive IC protocol to monitor inorganic extractables. For IC applications, our IC Acrodisc polyethersulfone (PES) syringe filters are certified for low levels of inorganic extractables. Actual background levels of filter extractables are typically less than 20 ppb for chloride, 6 ppb for nitrate, 1 ppb for phosphate, and 10 ppb for sulfate.

Automation Certification

Pall has specifically designed and certified our Acrodisc PSF syringe filters to be fully compatible and reliable for use with automated equipment. The following special features make our syringe filters reliable for worry-free performance 24 hours a day:

- Smooth filter-to-filter release
- Consistent turret advancement
- Exceptional housing strength
- Strict “outside filter geometry”

Manufacturing Quality Assurance

Quality Control

In addition to the HPLC certification performed to evaluate UV absorbing extractables, Acrodisc syringe filters are subjected to quality control testing. These tests ensure compliance with the product's specifications.

The quality control tests include:

- Visual quality tests
- Liquid flow rates
- Bubble point
- Burst test
- Liquid UV/IC extractables for certification

UV Absorbing Extractables

UV absorbing extractable testing is performed to verify that a product intended for use in HPLC sample preparation will not contribute a significant amount of UV absorbing extractable materials to the sample fluid. This test is intended for all filters that are HPLC certified.

Bubble Point

Statistically representative samples from each lot of Acrodisc syringe filters are selected and tested by the bubble point test to confirm pore size and integrity of the membrane seal. A bubble point is the measure of the amount of air pressure required to force an air bubble through a wetted pore and is in inverse proportion to the size of the hole. The bubble point rating is determined when the largest pore yields a bubble; the larger the pore, the less pressure required to form the bubble. Bubble point is expressed in units of pounds/square inch (psi), bar or mbar, or kPa for membranes. (ASTM: F216-80)

Burst/Pressure Test

Acrodisc syringe filters are tested for resistance to pressure. This test is a quality and safety test to ensure the Acrodisc syringe filter housings will not rupture at their rated operating pressures. The maximum operating pressure listed in the product literature is well below the actual burst pressure. This pressure rating is tested on every lot of filters.

Visual Examination

A machine vision system inspects Acrodisc PSF syringe filters throughout the production process for cosmetic defects. Operators and technicians verify the pad printing on the Acrodisc syringe filters. Lettering quality, accuracy, and proper color-coding stamped on each device are inspected. Package labeling is examined for accuracy of label information.

Ion Chromatography Extractables

The IC Acrodisc syringe filter is eluted with 18-Megohm/cm water to determine that the quantity of ionic extractable materials is sufficiently low and that the product will yield accurate analytical results when used in IC experiments. This test is applicable to all filters certified for use in ion chromatography.

Liquid Flow Rate Test

Liquid flow rate tests are performed to ensure that the Acrodisc product meets flow rate specifications. To perform this procedure, the syringe filter is attached to a regulated, pressurized source of test fluid and the flow rate is determined from the volume of fluid processed in a specific time interval.

Mass Spectrometry

The Acrodisc MS syringe filter is eluted with 50:50 acetonitrile and water and analysed by mass spectrometry. The filtrate and an unfiltered sample are compared to ensure that there are no interfering extractables from the filter. This Total Ion Current (TIC) chromatogram and certification accompanies all lots of the filter, certifying it for Mass Spectrometry use.

HPLC Certified Membranes from Pall Recommended Uses

Membrane	Strong Bases	Acids	Aqueous Solutions	Ketones
Fluorodyne® II		●	●	
Nylaflo® (Nylon)	●		●	●
TF (PTFE)	●	●		●
IC Supor® (PES)	●	●	●	
water wettable Polytetrafluoroethylene (wwPTFE)	●	●	●	●

Note: Be sure to review the Chemical Compatibility Guide on page 29 before choosing a filter.

Need for Filtration

Sample and mobile phase filtration are simple, economical practices that serve to extend the life of consumable HPLC parts, decrease system wear and tear, and preserve the integrity of the HPLC system. The adverse effects of improper filtration practices that occur to each component of the HPLC system are systematically and thoroughly explored in this section. By reviewing these consequences, the analyst can become familiar with the early warning signs of filtration-related problems and avoid the expense and downtime related to lengthy maintenance repairs and replacement costs.

Sample and mobile phase filtration are simple, economical practices that serve to extend the life of consumable HPLC parts.

Serious problems in HPLC can be avoided by being alert to preliminary warning signs and performing routine maintenance. Most HPLC part replacement tasks, such as changing pump seals, are readily recognized as necessary maintenance; however, mobile phase and sample filtration are also maintenance practices. Routine sample and mobile phase filtration are simple, inexpensive, and convenient ways to decrease HPLC problems. Regardless of the technical intricacies and cost of the system chosen, all HPLC systems have the same basic components, indicated in Figure 1.

A basic HPLC system consists of a solvent reservoir, pump, injector, column, detector, and data recording system. Particles and microbial growth not removed by filtration interfere with nearly every system component.

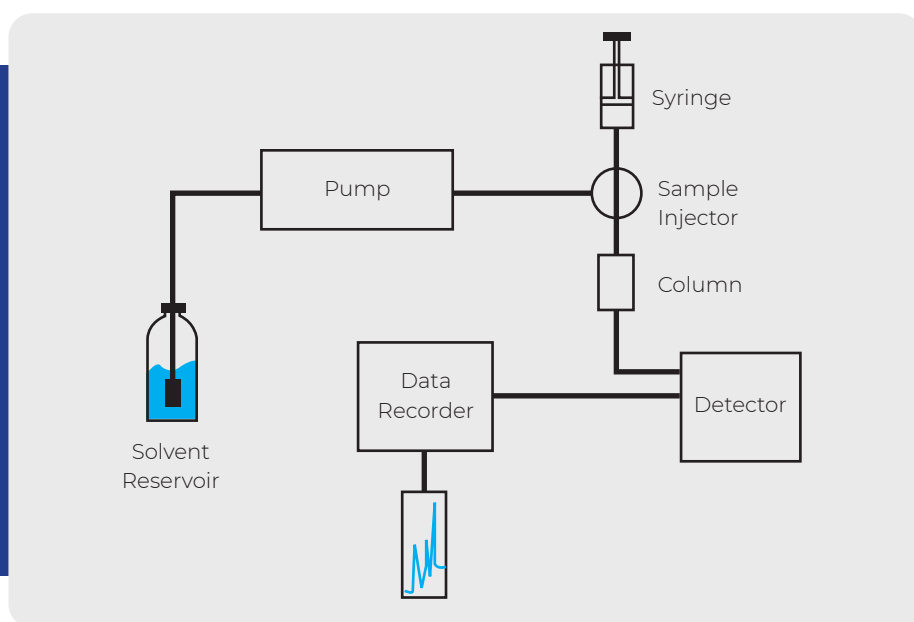

Figure 1: Basic HPLC system

Solvent Reservoir/Solvent Degassing

The solvent reservoir traditionally includes an inert container, vented cap, PTFE solvent inlet line, and a 10 μm gross inlet sinker frit. The solvent reservoir is generally equipped to degas solvents by removing dissolved air. Frequent mobile phase degassing reduces erratic pump delivery of the solvent due to pressure fluctuations, and hence reduces detector noise. Degassing removes dissolved oxygen that can result in oxidative degradation of the sample and mobile phases, which reduces the sensitivity and operating stability of ultraviolet, refractive index, electrochemical and fluorescence detectors. By filtering the mobile phase, analysts can reduce debris capable of plugging the sinker and column frits, causing contamination, damaging pump valves, blocking capillaries, causing poor peak performance, and contributing to extra peaks and excessive chromatographic noise.

Mobile phase filtration is performed prior to placing the solvent into the solvent reservoir. Buffered mobile phase solvents require daily filtration with a 0.2 μm filter to eliminate microbial growth that could increase the baseline.

A typical solvent filtration apparatus is depicted in Figure 2. Contamination concerns from the filtration apparatus deter many analysts from filtering solvents. By dedicating a reservoir to each solvent, and frequently changing and cleaning the reservoir bottle and sinker frit, contamination problems are reduced. All filtration should be performed prior to placing the mobile phase in the solvent reservoir. Most typically, a glass filter funnel and flask assembly is used.

However, this requires each reservoir to have a dedicated funnel and flask to eliminate cross contamination. The solvent bottle must also be lifted high above the lab bench to fill the top of the funnel assembly, creating a health and safety hazard.

These concerns can be alleviated using Pall's SolVac® device which is a filter holder that fits directly on to the top of the solvent reservoir. The SolVac device depicted in Figure 3, eliminates the need to have dedicated filtration apparatuses by minimizing cross contamination when filtering multiple solvents. SolVac devices also prevent the hazards associated with elevating solvent bottles high above the lab bench. Using the SolVac device eliminates the need to continually pour and wait for the sample to filter, continually refilling the funnel as space allows.



Figure 2: Mobile phase filtration apparatus

Figure 3: SolVac filtration device



The primary concern when choosing a solvent filter is solvent compatibility with the filter material. Pall offers several filters to accommodate the various types of HPLC solvents. Pall's PTFE membrane is a universal membrane that eliminates confusion with filter selection. Typical solvent filters range in size from 25 to 90 mm in diameter and are available in a 0.2 or 0.45 μm membrane pore size.

Pump

The pump is the single most important component in the HPLC system. Reliable pump operation requires attention to system cleanliness, solvent and reagent quality, mobile phase filtration, and mobile phase degassing. The four most common pump problems involve 1) check valves, 2) pump seals, 3) blockage, and 4) air bubbles. Incorrect pump functioning results in increased baseline noise, irreproducible retention times, and increased operating pressures.

A pump delivers flow rates between 10 $\mu\text{L}/\text{min}$ and 10 mL/min . Pumping fluid at 10 mL/min against a small particle column generates considerable pressure. If the pump is circulating unfiltered mobile phase through the small interstitial spaces within the packed column, particulate build up is possible. Monitoring pressure changes allows for quick assessment of blocked frits, or columns, through exaggerated pressures. Retention times also may be affected by changes in system pressure. Bubbles form in the pump when mobile phase mixtures become air saturated. Bubbles interfere with piston and check valve operations, causing erratic flow and pressure fluctuations. To resolve blockage or bubbles, contact your system manufacturer for the best preventive maintenance procedures.

Check valves control the solvent flow direction through the pump head and ensure steady pressures when sealed properly. Particulate in check valves can leak or stick causing flow and/or pressure problems. Check valve leakage is prevented by filtering HPLC-grade solvents, using a solvent line sinker frit, flushing the system daily with non-buffered mobile phase, and regularly replacing pump seals to remove particles and entrapped air causing leakage and pump pulsation noise. Pump pulsation noise is the flow change sensed by the detector from piston movement and check valve operation. Filtering the mobile phase solvent aids in decreasing this contribution to noise. A series of increasing polarity solvent flushes should be sufficient to remove problems due to sticking and particulates.

Pump seal life can be extended by filtering the mobile phase solvents.

A pump seal facilitates piston movement in the pump head. Pump seals wear more quickly than other pump parts, and therefore require changing every three to six months. A failing pump seal is evident from an inability to pump at high pressures, leakage behind the pump head, and change in sample retention. Pump seal wear can result in sloughing seals and contamination from this material. Buffer crystals built up from evaporated mobile phase also will accelerate wear. Pump seal life can be extended by filtering the mobile phase solvents to remove the particles responsible for accelerated seal wear.

Injector

Injecting clean samples prolongs injector and column life. Samples are cleared of particulate and bacteria with disposable syringe filters. Disposable filters range in size (4-25 mm) and pore size (0.2-1.0 μm). Filters are membranes enclosed in plastic housings that attach to a syringe with a luer fitting. Samples are filtered by drawing fluid into the syringe, attaching the filter, and dispensing the sample through the filter into a vial. Table 1 lists various types of membrane filters incorporated in syringe housings, housing material, and prefilter materials. To reduce physical and chemical variability among manufacturers, sample and mobile phase filtration products should be purchased from the same manufacturer.

Filtering your sample prior to injection can prolong your injector and column life.

Table 1
Standard materials incorporated in syringe filters

Membrane Material

Nylon, PTFE, Polyvinylidene Fluoride (PVDF), Polyethersulfone, Acrylic Copolymer, w/PTFE

Housing Material

Polypropylene (PP), Polyethylene (PE), Modified Acrylic

Prefilter Material

Glass, Polypropylene, Polyethersulfone

Choosing the proper filter requires knowledge of filter/solvent compatibility and the chemical/physical characteristics of the filter. These characteristics include pore size, pore distribution, filter thickness, extractables, hydrophobic/hydrophilic character, binding properties, pyrogenicity, gas and liquid flow rate, burst strength, autoclavability, pore size, and nominal particulate retention. Typically for HPLC applications a 0.45 µm pore size filter is selected, while for bacterial removal or UHPLC applications, a 0.2 µm filter is chosen. For particulate-laden samples, Pall incorporates large pore size prefilters in one device with smaller pore size membranes. Low protein binding and sterile filters also are available.

Sample and solvent filtration helps protect low-volume injector fittings from blockage, scratching, and leakage.

HPLC injectors are available in several styles including a septum, septumless stop-flow device, and a manual or automated valve system. A valve injector is most typical. An injector should ensure reproducible sample introduction. Sample and solvent filtration prevents low-volume injector fittings from blocking, scratching, and leakage. Loop or waste line blockage results in high back pressure and loop filling difficulty. Low dead volume fittings, located between the valve injector and column to decrease band broadening, also are subject to blockage. Other contributors to HPLC problems include mismatched or damaged injector components, variable sample volumes, leaks, and increased system pressure. With filtration, properly adjusted and clean injectors should last 5,000 injections.

Autosamplers run unattended, so clean filtered samples will decrease malfunction. Clean sample vials, free of dust and other particulates, also contribute to clean samples. Particulate-free samples are essential to decrease blocked sample needles, connection tubing, and injectors. Connection tube blockage results from sample particulate, septum fragments, or small internal diameter tubing. Sample, mobile phase, and in-line filtration products deter these situations. For blockage at the injector's low-pressure side, the needle and needle valve tubing should be checked. Symptoms include smaller than expected peak heights and peak absence. On the high-pressure side, find the location by loosening the connection fitting, starting at the column head, and working upstream. Once the blockage is located, backflush with a clean filtered solvent.

In-line Filters and Guard Columns

In-line filters and guard columns can remove particulate before the main column. These two filters are configured into the HPLC system as follows: sample injector—in-line filter—guard column—main column. They are not intended to replace sample pretreatment, or sample and solvent filtration. Particulate-laden samples will quickly overload the in-line filter and guard column allowing particles to enter the main column. In-line filters are important because it is impossible to avoid particulate from system wear, such as polymeric seal wear from the pump and sample injector, except with an in-line filter. In-line filters function to reduce blockage of the column frit and the back-pressure restrictor. The in-line filters should have removable frits of 0.45 to 2.0 µm for frequent replacement and low dead volume housings.

Guard columns can collect chemical and physical waste that block the main column inlet, cause column voids, and degrade performance. The guard column retains irreversible and strongly bound components that degrade the column and decrease its lifetime, providing an inexpensive alternative to frequent column replacement. The frits of a guard column are typically 2.0 µm, which is not sufficient for particulate removal. Sample and mobile phase filtration will preserve the capacity of the guard column for its intended use – chemical contamination removal.

Sample and mobile phase filtration will preserve the capacity of the guard column for its intended use.

Columns

Proper HPLC column selection is crucial for efficient compound separation and identification. High performance columns are composed of small particles of narrow size distribution. Optimal peak profiles depend on column operating characteristics and should be instrument independent. Columns, depending on sample type, sample preparation, and operator filtration practices, can handle a few to several thousand injections. Two significant problems with HPLC columns are chemical and physical changes. Chemical changes are prevented with guard columns. Physical changes involve blocked frits and channel voids. Voids are created by particulate matter and pressure shock. If poor peak shapes become evident through badly tailing, splitting, and non-gaussian bands, without a change in retention time, blocked frits or a column void has occurred.

The following are tips from instrument manufacturers to prevent physical changes:

- Filter solvents through a 0.2 or 0.45 μm filter, such as a Pall Acrodisc syringe filter
- Prefilter mobile phase buffers daily with a 0.2 μm filter to remove bacterial growth
- Filter samples through a 0.2 or 0.45 μm filter
- Use a 0.5 μm in-line filter to trap injector and pump particulates

Prior to any action, ensure that the problem is from blockage or a void volume and not from a change in solvent strength, pH, temperature, or mobile phase additives, such as an ion-pairing reagent, which show the same effects.

Detectors.

Detectors for HPLC are classified as bulk property or solute property detectors. A bulk property detector measures the physical property difference of the solute in the mobile phase compared to the mobile phase alone. The solute property detector responds to physical or chemical properties of the solute and is independent of the mobile phase. Examples include spectrophotometry, fluorescence, and electron capture detectors. As detector sensitivity increases, the choice of filter media becomes more important. One of the most sensitive detector technologies available is mass spectrometry, which separates compounds by their charge to mass ratios. To address the special requirements of this technology, Pall has developed the Acrodisc MS, which utilizes a special unsupported WWPTFE membrane in a high-density polyethylene housing. These materials minimize the potential for low level extractables which would be detected by this highly sensitive technology.

Solutions for removing the negative effects of oxygen in detectors include filtering buffers through a Pall 0.2 or 0.45 μm membrane filter.

Insufficient mobile phase degassing causes pressure fluctuations and/or sharp noise spikes due to bubbles. Bubbles form when the mobile phase mixture becomes saturated with air. This interferes with detector operation. The presence of oxygen in the samples can cause oxidative degradation, leading to a decrease in sensitivity. Degassing methods include mobile phase filtration followed by a continuous degassing through helium sparging, ultrasonic treatment, vacuum application, or heating with vigorous stirring. Solutions for removing the negative effects of oxygen in detectors include continuous sparging, filtering buffers through a Pall 0.2 or 0.45 μm membrane filter, and using HPLC-grade solvents.

Tubing.

Tubing length and internal diameter require careful selection to prevent system degradation. The internal diameter is dictated by pressure requirements and can vary from 0.18 to 1.0 mm depending on flow requirements. Injector-to-column and column-to-detector tubing, typically stainless steel or Teflon is generally 0.25 mm. Applications where small peak volumes are required use microbore tubing. Small I.D. tubing blocks faster, but tube blockage is rare. More commonly, blockage occurs at in-line filters or frits. Effects of blockage include significant pressure rises, and fitting and seal leakage. Blockage, partial or complete, can be due to poorly filtered mobile phase, particles in the injected sample, pump/injector seal wear, leakage of silica particles from guard or analytical columns, precipitation of mobile phase salts, and any particulate matter in the HPLC system.

Filter Selection

There are four main considerations in choosing the best filter for your application. They are:

1. Is your filter application automated or manual?
2. What is the filter's chemical compatibility?
 - Resistance of membrane to fluid contact
 - Extractables
 - Adsorption
3. What Effective Filtration Area (EFA) is needed for your filtration?
4. What pore size rating is optimal for sample clean-up?

Filter Chemical Compatibility

Does the filter need to be resistant to bases, acids, or organic solvents? Chemical compatibility is a critical consideration when selecting the sample prep syringe filter or mobile phase disc filter for your application.

The following broad guidelines can be used for basic information.

Aqueous Samples

Hydrophilic membranes, which have an affinity for water, are preferable when filtering aqueous samples. Use Pall filters with wwPTFE, PES, Nylon, or PVDF membranes.

Gases and Aggressive Organic Solvents

Hydrophobic membranes repel water and are inert to aggressive organic solvents, making them ideal for gases and organic solvents. Choose Pall filters with PTFE membrane.

Aqueous and Organic-Solvent Solutions

Different polymeric membranes have different chemical compatibilities. Based on the application and chemical compatibility, there may be one or several membranes and Acrodisc syringe filter possibilities. Generally, one filter type will not function for all applications due to limitations in hydrophobicity/hydrophilicity and chemical compatibility. However, Pall hydrophilic wwPTFE membrane is a universal membrane for both aqueous and organic applications.



Exceptionally Low Extractable Levels

A filter is designed to increase accuracy by removing unwanted particles. However, the wrong filter can be a source of contaminants in the form of extractables that elute into the sample from the filter device. These undesired artifacts can jeopardize analytical results. Some extractable concerns include coelution, false quantitation, and extraneous peaks. Pall specifically selects the highest grade of materials and performs rigorous extraction methods on our membrane products to reduce undesired artifacts.

Sample Adsorption

Unwanted drug binding during routine pharmaceutical sample analysis can be a serious problem and cause out-of-specification results. No single analytical method can provide reliable information on comparative filter properties and the full range of extractables for all filters. Therefore, choose a low adsorption filter such as the Acrodisc One syringe filter with wwPTFE membrane. The wwPTFE membrane is extremely low in biomolecule and API binding. Typical binding levels are below 5%.

Most Appropriate Effective Filtration Area (EFA)

The particulate contained within a fluid affects the life of a filter. As particles are removed from the fluid, they block pores and reduce the usable portion of the filter. Particulate-laden fluids generally plug a filter more quickly than “clean” fluids. Increasing the EFA can lengthen the life of a filter.

Filters come in a variety of sizes ranging from the area within a single well of a 96-well plate, to spin filters and syringe filters. 25 mm Acrodisc PSF syringe filters, as well as 13 mm diameters for smaller sample volumes, are available in a variety of membrane and pore size choices.

Hold-Up Volume

Another aspect of choosing the right filter size is the hold-up volume. This is the volume of liquid remaining in the filter after use. A filter with a low hold-up volume is recommended for use with expensive fluids or those with limited availability.

Pall offers a broad range of device sizes. The minispike outlet, available on our 13 mm syringe filter, allows for minimal sample hold-up and easy dispensing into autosampler vials. Additional options include the Nanosep® MF centrifugal device, or AcroPrep™ Advance filter plates.

The table below outlines general guidelines to the appropriate filter size for different volumes of fluid.

Table 2: Selecting filter size for different volumes of fluid

Volume to be filtered	Device type	Typical hold-up volume
<500 µL	Nanosep MF Device	<2 µL
<900 µL	AcroPrep 96 1 mL Filter Plate	<18 µL per well
<2 mL	4 mm Acrodisc Syringe Filter	<10 µL
<10 mL	13 mm Acrodisc Syringe Filter (Minispike)	<14 µL
<10 mL	13 mm Acrodisc Syringe Filter	<30 µL
<125 mL	25 mm Acrodisc PSF Syringe Filter	<200 µL

For difficult-to-filter samples, the Acrodisc PSF syringe filter with GxF multi-layered glass fiber prefilters are the best option.

Consider Prefiltration

For difficult-to-filter samples, it is best to use a syringe filter with a glass fiber prefilter over the membrane. The Acrodisc PSF syringe filter with GxF multi-layered glass fiber prefilter is the best option for extremely particulate laden samples.

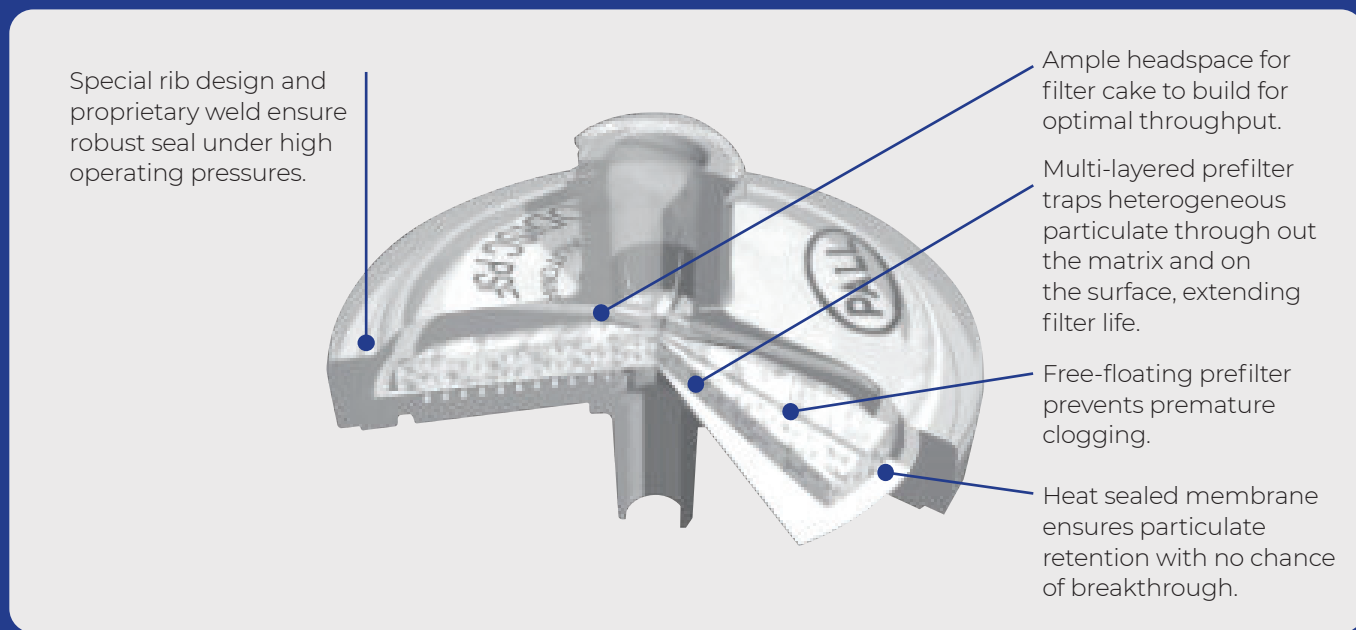

Figure 4: Acrodisc PSF GxF syringe filter

The Acrodisc PSF GxF syringe filter has a serial glass fiber (GxF) prefilter to allow for maximum throughput and faster flow rates than standard glass fiber prefilter devices.

The multi-layered prefilter, rated from >40 to 1 μm , traps particulate, thereby extending filter life.

Easy Identification

13 and 25 mm Acrodisc syringe filters and their packaging have color-coded printing with membrane type and pore size on each filter:

- | | |
|----------|--------------------------|
| ● wwPTFE | ● Nylon |
| ● PTFE | ● Glass Fiber |
| ● PVDF | ● Polyethersulfone (PES) |

Optimal Pore Size Rating

To extend the life of your column and reduce maintenance due to particulate in the pumping system, thereby giving more analyses per dollar spent, a filter's pore size should be determined based on the column packing size. As you can see in Figure 5, the column packing particles touch each other. Ideally, you would not want contamination to fit into the space between the particles of packing. This space (labeled Flow Path) is identified in Figure 5 below. The idea is to find out how large that space is and remove particles that size. For example: start with a 3 μm packing size and draw a few well-placed equilateral triangles as suggested in Figure 5. Determine the largest particle capable of fitting through the column by circumscribing an equilateral triangle with a side length of 0.75 μm .

Now enlarge the diagram and look further. Visualize a series of equilateral triangles whose side length gets down to 0.75 μm . Figure 6 illustrates a right triangle whose short side describes the radius of the sphere. The angle is one half of 60°, or 30°. The horizontal side of this new right triangle has a length of 0.375 μm (half of 0.75 μm). Calculating the tangent of 30° gives the ratio of the length of the opposite side over the adjacent side, in this case 0.58. This means that the short side of the triangle is equal to 0.58 x 0.375 or 0.217 μm . Coincidentally, this is also the radius of the particle. So, if the column packing is 3 μm in diameter, the flow path is 0.43 μm .

When an HPLC column has a packing size of 3 μm or smaller, you should use a 0.2 μm Acrodisc One syringe filter because a 0.45 μm syringe filter may let particles through that will plug the column.

Are You Concerned About Accurate Retention of Particulate?

For liquid chromatography systems using columns with larger than 3 μm packings, the filtration industry standard is 0.45 μm for syringe filters and mobile phase membranes. For columns with 3 μm or smaller packings, including Ultra High Performance Liquid Chromatography (UPLC) microbore columns, or when concerned about microbial growth, a 0.2 μm filter is recommended.

Once the best pore size rating is chosen for the application, you must rely on the filter manufacturer to provide an accurate pore size rating.

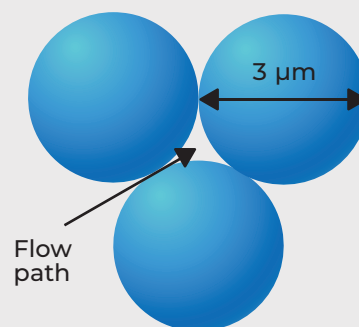
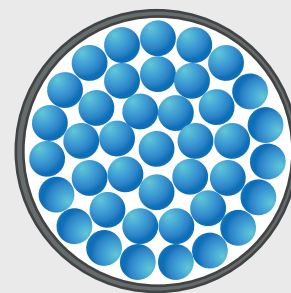

Figure 5

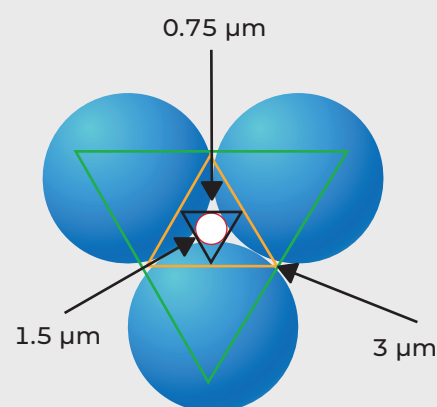

Figure 6

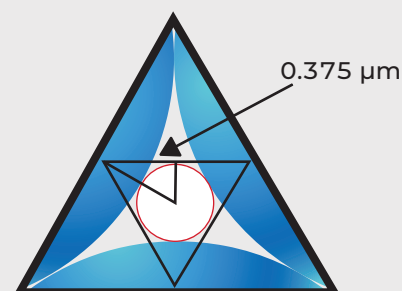

Figure 7

Extending HPLC Column Life

Injection of particulate-laden samples will block HPLC columns, shorten injector life, and result in extensive maintenance on pumps. Particulate finding its way into a column will result in increased column backpressure, disrupted nominal band shape, and reduced plate number, consequently shortening column life and making analytical results difficult to interpret. Using the Pall Acrodisc One syringe filter with wwPTFE membrane is the most efficient way to remove particulate and prolong the life of HPLC system components. The average retention efficiency of 0.45 μm rated Acrodisc One syringe filter at removing 0.45 μm average diameter latex spheres is 94%. When compared to filters from two other manufacturers, Pall Acrodisc One syringe filters significantly prolonged HPLC column life with virtually no backpressure increase after 1000 injections.

Compared to other manufacturers, Pall Acrodisc One syringe filters significantly prolonged HPLC column life.

Background on Column Failure

Of the four common causes for HPLC column failure (plugging, voids, adsorbed sample, and chemical attack), plugging is the most frequently encountered by analytical chemists or analysts. Injection of samples containing particulate will eventually block the column inlet, cause high column backpressure, and shorten the normal lifetime of the column. Operations of pump components, injectors, and detectors can be expected to be less troublesome when fluids are filtered. For HPLC applications, the 0.45 μm pore size filter is typically selected for removal of particulates. Although there are several seemingly equivalent such products on the market, lack of knowledge about the differences between filters leads to more frequent column replacement and extensive operation downtime.

Filtration as a preventative maintenance tool for HPLC analyses is well documented. It is commonly taken for granted that column life will be extended if samples are filtered prior to injection, but the extension of the column life has not been well quantified. It is the intent of this work to demonstrate that filter efficiency must be considered when choosing an HPLC sample prep filter and that filtration will lengthen the life of a column.

Retention efficiency of two effectively equivalent 0.45 μm rated syringe filters (Pall and Competitor) were examined using 0.45 μm average diameter latex spheres. This work was conducted with latex spheres to offer the best possible reproducibility in both sample preparation and filter efficiency measurements.

In order to correlate the retention of spheres to the actual application, the quantitative effect of filtration on HPLC column life was investigated. This involved examining column life without filtration compared to column life when samples were filtered. It should be recognized that extending the column life is dependent on the particulate within the sample and actual column life extension may vary.

Test Methods

Materials

- Latex spheres and surfactant were purchased from Sigma-Aldrich. 0.45 μm average diameter latex spheres
- 25 mm syringe filters with 0.45 μm pore size ratings were obtained from Pall and Competitor

Instrumentation

- High Performance Liquid Chromatography (HPLC)
- Watersu (Milford, MA, USA) 616 Pump
- Waters 600s Controller
- Waters 717plus Autosampler
- Ultraviolet/Visible Spectrophotometer (UV/VIS), HP 8452A Diode Array

Columns

- Lunau 5 μm C18(2) Size: 30 x 3.0 mm (Phenomenex, Torrance, CA, USA):

Testing

The UV/VIS Spectrophotometer was used for measuring absorbance of latex-sphere solutions. The maximum absorbance of the latex-sphere solution was observed at 272 nm, which was used to correlate latex sphere concentrations with absorbance. The surfactant solution, 0.1% Triton X-100 that is free of latex spheres, was measured as the blank at 272 nm. A series of standard solutions of 0.0025%, 0.0050%, 0.0075%, and 0.01% 0.46 μm latex sphere concentrations were made and used for creating the calibration curve. The linear relationship between latex sphere concentrations and absorbance was established, which is in accordance with Beer's law. A correlation coefficient of 1.0000 was obtained. The 0.01% 0.46 μm average diameter latex spheres solution was used for the retention efficiency study. The challenge solution was passed through each individual syringe filter and a 3 mL eluted aliquot was collected and analyzed at 272 nm. Three different filters from each of the three lots were tested (i.e., nine filters from each manufacturer were individually analyzed).

The HPLC was utilized for the column-plugging study. Column life was evaluated by comparing initial backpressure to backpressure after injections. A new column was installed. The outlet of the column was disconnected from the detector and allowed to run to drain. This modification allowed quicker injections for a more efficient determination of column backpressure. Acetonitrile:Water (35:65, percentage by volume) was used as mobile phase, with a flow rate of 1 mL/min. Column temperature was controlled at 25 °C. The system was set to automatically inject 50 μL each time. The column-plugging solution consisted of 0.05% (by weight) 0.46 μm average diameter latex spheres in 0.002% Triton X-100 solution. The first step was to inject this solution without any filtration to see how long the column would last without filtration. After the column was plugged (i.e., column backpressure reached 3500 psig, 241.3 bar, 507.6 kPa), a new column was installed. This time the same latex-sphere solution was subjected to filtration using Competitor filters. Thirty samples were generated with 30 filters (ten from each of the three lots). The injections were carried out from sample vial 1 through vial 30 and then repeated in this sequence. The column backpressure was recorded with the number of injections. This procedure was repeated with new a column for Pall filters.

Test Results and Discussion

Latex Sphere Retention for Filters from Two Manufacturers

Pall Acrodisc One syringe filters with wwPTFE membrane retain an average of $94.3 \pm 3.0\%$ of the 0.46 μm average diameter latex spheres. By comparison, Competitor syringe filters can only remove an average of $77.1 \pm 17.5\%$ of the latex spheres.

Instrumentation

Figure 8 depicts the relationship between column backpressure and number of injections. Without filtration, the column failure due to plugging occurred after only 19 injections. After the 0.05% latex-sphere solution was filtered with Competitor filters, the column was plugged after 500 injections. When the 0.05% latex-sphere solution was filtered through Pall Acrodisc One syringe filters with wwPTFE membrane and injected into the HPLC system, the column backpressure did not increase after even 1000 injections.

Figure 8

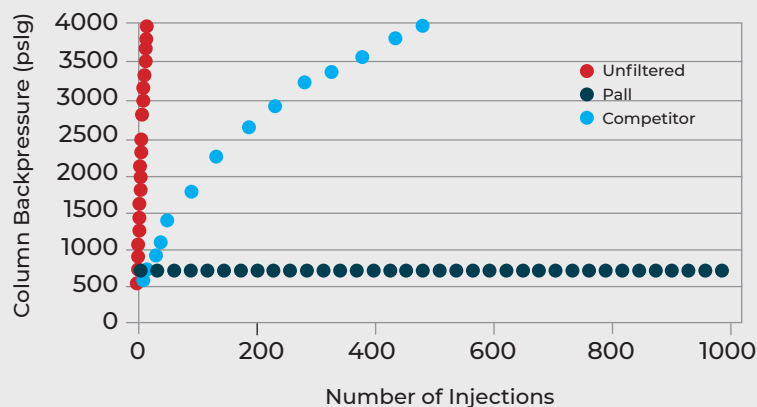

Effects of filters on HPLC column life following injections of unfiltered and filtered 0.05% latex sphere suspensions(1). With unfiltered samples, the column failed due to plugging after 19 injections. Samples passed through Competitor filters plugged the columns after 500 injections. No increase in backpressure was observed after 1000 injections of samples filtered with Pall Acrodisc® One syringe filters.

Test Results and Discussion

Among 0.45 µm rated filters the Pall Acrodisc One syringe filter with wwPTFE membrane has higher average retention efficiency of latex spheres. We have shown that it is imperative that samples be filtered prior to their introduction into a HPLC system. Equivalent filters from various manufacturers (Competitor and Pall) with the same removal rating differ in capabilities. Using Pall Acrodisc One syringe filters with wwPTFE membrane prolonged the column life 52 times with no increase in column backpressure.

Using Pall Acrodisc One syringe filters with wwPTFE membrane prolonged the column life 52 times with no increase in column backpressure.

Extractables and Maintaining Analytical Integrity During Sample Preparation

Pall manufactures a complete line of Acrodisc and Acrodisc PSF syringe filters for analytical sample preparation. Because HPLC and other analytical methods are very sensitive and serve as qualitative and quantitative techniques, it is important to preserve the integrity of the sample. To demonstrate Pall's quality product offering, an investigation to evaluate the amount of extractable materials added from analytical syringe filters follows.

What Are Extractables and Where Do They Come From?

A syringe filter extractable is an undesired artifact contributed to the sample fluid from the filter device. This material may be a membrane or housing formulation component, or a component introduced during the manufacturing or packaging process. There are several mechanisms (solubility, particle displacement, chemical interaction, and diffusion) whereby extractable materials may leach into the sample during sample preparation. Of these mechanisms, solubility and particle displacement are more prevalent. The appearance of extractable materials from a syringe device depends on the solubility of device components in the sample fluid. The polymeric resins, solvents, pore formers and other chemical components such as housing materials utilized during device manufacturing may potentially extract. Solubility directly relates to chemical compatibility.

As membrane and/or housing components become more soluble with sample fluid components, extractable materials will increase. To determine whether a syringe filter is compatible with the sample fluid, all sample constituents (both major and minor components) require consideration. Because solubility is dependent on temperature, concentration, and exposure time, these parameters are significant in determining chemical compatibility. Displacement can occur when residual manufacturing materials, once caught in the pore structure of the membrane, are dislodged. Pall performs rigorous extraction methods on their membrane products to prevent the risk of this occurrence.

Why Are There So Many Different Acrodisc Syringe Filter Types?

Different polymeric membranes have different chemical compatibilities. Based on the application and chemical compatibility, there may be one or more Acrodisc or Acrodisc PSF syringe filter possibilities. For example, PVDF or wwPTFE membranes are recommended for sample fluids possessing strong acidic character. Nylon membrane is not recommended for such samples. Conversely, nylon or wwPTFE, would make a better choice for fluids characterized as strong bases, while PVDF membranes are not suggested for these fluids. If the fluid contains aggressive organics, wwPTFE or PTFE membranes are recommended. Reviewing and understanding the Pall Chemical Compatibility Guide will assist in making the best choice.

Generally, one filter type will not function for all applications due to limitations in hydrophobicity/hydrophilicity and chemical compatibility. However, Pall's wwPTFE membrane is suitable for use in the majority of applications. It has excellent chemical compatibility for aqueous and aggressive organic solvents. Pall's wwPTFE membrane is hydrophilic and ideal when selection is difficult for complex sample matrices. The option of a built-in glass prefilter (GxF/wwPTFE) is also available for heavily particulate-laden samples.

Pall wwPTFE membrane can be considered a universal membrane for all applications.

When Are Extractables a Concern?

Extractable materials can jeopardize analytical results. For chromatographic analysis, scenarios resulting from extractable materials include sample absorption, coelution, and extraneous peaks. Anomalous results are an analyst's nightmare because procedures typically require action to remedy or identify miscellaneous and unexpected peaks. Typically, if unknown peaks in a pharmaceutical chromatogram (extractables) equal 0.1% of the total area then they must be investigated.

Extractable materials become even more of a concern as the amount of analyte diminishes. With recent HPLC column trends utilizing smaller inner-diameter columns (< 1 mm for micro LC) and smaller packing sizes, the ability to separate and detect trace quantities of material is increasing. With these improvements comes increasing concern for the effects of extractable materials.

How to Avoid Extractables' Negative Effects?

There are three primary methods to avoid the negative effects of extractable materials. Application testing preserves analysis validity. To application test, analyze the sample fluid before it is filtered. Compare these results to the results obtained after the sample is filtered. If any quantitative or qualitative differences occur, select another filter type. Another method of application testing involves evaluating the results obtained from passing the matrix solvent through the syringe filter and evaluating the results. This will demonstrate if material will extract with the neat solvent. Flushing is a third method. When excess sample fluid is available, discard the first few milliliters of fluid eluting from the syringe device. Generally, the amount of extractable materials eluted from the filter diminishes with the volume passed through the filter. As will be shown in this study, a 3 mL flush is usually adequate to reduce extractables to an acceptable level.

What Contributes to an Acrodisc Syringe Filter's Quality?

Membrane manufacturers use proprietary formulations and different manufacturing techniques. For this reason, Pall's membranes and Acrodisc and Acrodisc PSF syringe filters are not the same as other look-alike products. The specific quality of raw materials, amount of quality control, membrane extraction procedures, and post-treatments all affect the resultant membrane properties and amount of extractable materials. Pall specifically selects the highest grade of materials and performs several extractions to ensure that the product is free from extractable materials for sample preparation. Additionally, our polypropylene housing material, is the highest grade of plastic with minimal additives, and passes United States Pharmacopeia (USP) Biological Reactivity Test, In Vivo <88> plastics testing.

What Confidence Can You Have in Our HPLC Certification?

The following extractable experiments are provided to demonstrate the quality of the Acrodisc and Acrodisc PSF syringe filter product lines, which include wwPTFE, PVDF, nylon, and PTFE. To suit a broad audience, extractable experiments were performed under typical HPLC conditions with common mobile phases and extraction solvents. This information extends to the corresponding membrane disc for mobile phase filtration and other sizes of Acrodisc syringe filters, as the filter materials are the same.

Experimental and Instrument Conditions

The first set of extractions represented by the enclosed chromatograms resulted from volumetrically collecting the first milliliter of solvent through the Acrodisc syringe filter. This step was repeated with two additional filters. All three extracts were combined in an autosampler vial and analyzed, so that three filters contributed to one sample. Three filters were selected to remove potential variability among the filters. By collecting only one milliliter of eluent per filter, the ability to detect extractable materials was enhanced. HPLC analysis was performed on all fluid extracts with a Waters Acquity UPLC System with a Photodiode Array (PDA) Detector. The column, also supplied by Waters, was a Nova-Paku 4 µm C18, 4.6 mm x 150.0 mm. All extraction and mobile phase fluids, acetonitrile, water, and methanol were HPLC Grade Solvents.

The extracted fluid and neat solvent blanks, 100 µL of each, were analyzed under gradient mobile phase conditions. Initial conditions were held for three minutes, 95% water: 5% acetonitrile, and altered in a linear gradient over 40 minutes to the final conditions, 100% acetonitrile: 0% water, which were retained for five minutes. The system was equilibrated for 10 minutes before reinjecting. The wavelengths of interest, 214, 254, 280 nm, were acquired simultaneously with the PDA Detector.

Additional manufacturers of 25 mm syringe filters were included in this analysis. Only the Pall's products will be identified. For anonymity, the other manufacturer will be identified as Competitor. All filters were extracted according to the outlined procedure with three extraction solvents (methanol, acetonitrile, and water), and analyzed at three wavelengths (214, 254, and 280 nm). From this data set, the chromatograms that present the most useful information will be presented. In all studies, the neat solvent was simultaneously analyzed. The solvent analysis, when compared to the other chromatograms, helps to determine if the peaks are from the solvent or the syringe device.

Pall Acrodisc One wwPTFE Syringe Filters

The chromatograms in Figure 9 provide examples of the neat methanol and acetonitrile extractions of Pall's wwPTFE Acrodisc One syringe filter and Competitor syringe filters read at 214 nm. Once again, the results are indicative of the differences in membrane and housing materials, and manufacturers' procedures

Figure 9:

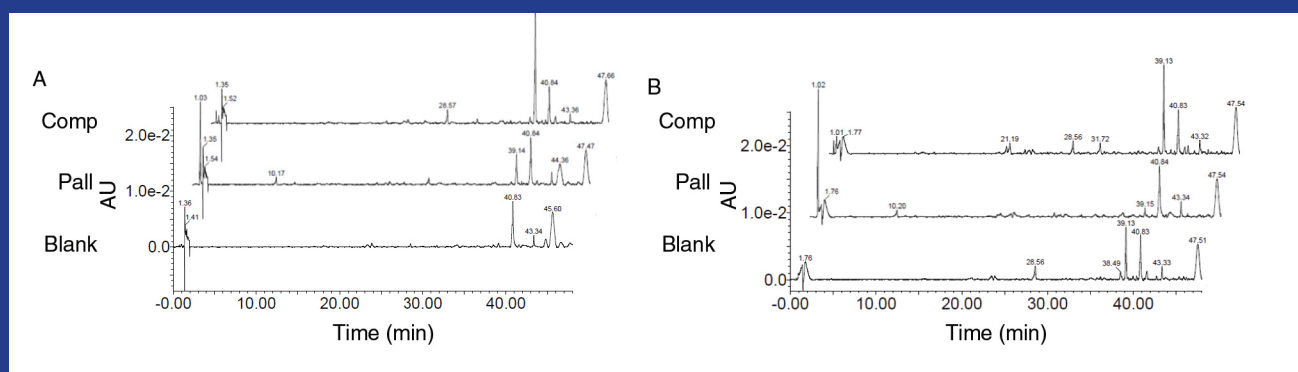

Solvent extractable properties of syringe filters equipped with 0.45 μm hydrophilic PTFE membranes (Pall and Competitor). For Panel A, the solvent was Methanol and acetonitrile for Panel B. Fifty microliter volumes of filtrate (Pall and Competitor) and solvent blank (Blank) were analyzed using a Waters Acquity UPLC system with a Diode Array Detector and a 2.1 x 50 mm, 4 μm Waters Nova-Pak C18, 4.6 mm X 150 mm reverse phase column under gradient conditions with a mobile phase consisting of water and acetonitrile with a flow rate of 1 mL/min and a column temperature of 30 $^{\circ}\text{C}$. Initial conditions of 5% acetonitrile were held for 3 min, then to remain at 100% acetonitrile for 91 min. The column was then equilibrated for 108 min at 5% acetonitrile before injection of the next sample. Data was collected at a wavelength of 214 nm.

Conclusion

By reviewing the data presented in Figure 9, it is demonstrated that syringe filters, although similar in design and materials of construction can be dissimilar with regard to extractable materials. Pall uses high quality raw materials and performs thorough post-treatment processes on membranes that will be used in its HPLC product line to minimize the occurrence of extractables. To verify low levels of UV-detectable extractables, samples of the entire HPLC Acrodisc syringe filter product line are evaluated during the manufacturing process.

Pall's HPLC certification is additional assurance that Acrodisc, Acrodisc PSF and Acrodisc One syringe filters have been optimized to minimize extractable materials. This conveys to our customers that each lot meets the high standards of Pall's quality assurance department.

It also means our customers can expect reliable, reproducible results without compromising the integrity of the sample being filtered. With little or no extractables from the filter, extraneous peak identification due to filtration can be eliminated.

Application testing is recommended to determine the best membrane filter selection for specific applications.

Suitability of Various Filters for Sample Preparation in Dissolution Testing, Based on Drug Binding

Filtration is a common method of sample preparation in dissolution testing, prior to a HPLC injection. The purpose of sample filtration is to remove non-dissolved solids prior to a HPLC injection. Non-dissolved solids interfere with the resulting chromatography by continuing to dissolve throughout the period of the analysis and by plugging the HPLC column. It has already been shown that sample preparation using filtration will result in more reproducible chromatography and longer column life.

There can be potential drawbacks with filtration as a preparation for HPLC analysis in dissolution testing. The first is that the filter may adsorb API from the drug mixture, leaving the concentration in the filtrate too low and out of specification (OOS).

Unwanted drug adsorption, as well as the presence of possible extractables eluted from the filter during routine pharmaceutical sample analysis, can be a serious problem and cause OOS results. No single analytical method can provide reliable information on comparative filter properties and the full range of extractables for all filters.

Extractables have already been discussed, therefore, this study will evaluate filters for adsorption of API. The drug product selection and product formulations in this study represent a wide variety of compounds that differ in chemical structures, ionization properties, and molecular weights, and therefore, differ in binding propensity. Also, a broad range of media for the sample preparation is matrixed into the study to evaluate elution profiles of each filter. All experiments are designed based on well-characterized (validated) USP methods. This study will demonstrate that correct selection and use of syringe filters makes the amount of API removed by the syringe filters too small to affect the HPLC determination. To do this, seven drug products are each evaluated with syringe filters. The seven drug products represent a variety of molecular structures and chemistries and therefore are expected to demonstrate a range in adsorption to the filter membranes.

Experimental Determination

There are many HPLC grade syringe filters from which to choose. The filters tested include the Acrodisc One syringe filter with 0.45 μm wwPTFE membrane and the Acrodisc One syringe filter with GxF prefilter and 0.45 μm wwPTFE membrane.

The active pharmaceutical ingredients (APIs) used in this evaluation represent a range of different functionalities and structures and should, therefore, demonstrate a range of adsorption to membrane filters. As seen in Table 3, the chemical structures vary from single aromatic rings to multiple aromatic rings to a non-aromatic, polycyclic structure. Included in the study are an acid, a base, an amide, a urethane, an ester, and a lactone structure. The physical structures vary from a more flat and planar structure like that of acetaminophen to the flat but flexible structure of ibuprofen and ranitidine HCl to the more rigid and distinct three-dimensional structures of omeprazole and clotrimazole.

Table 3
Pharmaceutical Products

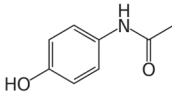
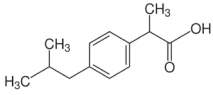
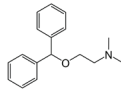
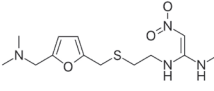
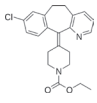
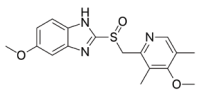
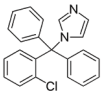
Drug Product (Brand Name)	Molecule Type	Molecular Structure	HPLC Mobile Phase
Acetaminophen (Tylenol) Tablets	Acetamide MW 151.16		Mixture of organic (MeOH) and water (25:75)
Ibuprofen (Motrin) Tablets	Phenylpropionic acid MW 206.28		Mixture of organic (ACN), and aqueous chloroacetic acid buffer (60:40), pH 3.0
Diphenhydramine (Benadryl) Tablets	2-(Diphenylmethoxy)-N-N-dimethylethylamine MW 291.82		Mixture of organic (ACN), and aqueous buffer, pH 3.0
Ranitidine (Zantac) Tablets	Hydrochloric salt MW 350.87		Mixture of organic (ACN), and aqueous phosphate buffer, pH 7.1
Loratadine (Claritin) Tablets	Pyperidine carboxylate MW 382.88		Mixture of organic (ACN and MeOH), and aqueous phosphate buffer (60:60:70), pH 7.2
Omeprazole (Prilosec) Tablets	Benzimidazole MW 345.42		Mixture of organic (ACN and MeOH), and aqueous glycine buffer, pH 9.0
Clotrimazole (Lotrimin) Tablets	1-[(2-chlorophenyl)-diphenylmethyl]imidazole		Mixture of organic (ACN) and aqueous phosphate buffer (75:25) MW 344.84

General Methodology

USP methods are intended for drug testing. Slight modifications to the sample handling in the methods are necessary for filter comparison rather than drug testing. Well-characterized pharmaceutical samples are analyzed in duplicate and triplicate followed by statistical evaluation, which allows for increased reliability of the drawn conclusions on filter suitability.

Results are obtained by HPLC analysis with UV detection. All calculations are performed according to each specific USP procedure against the appropriate, well-characterized (certified), corresponding USP reference standard. Label claim percentage (% LC) of each drug is calculated as a ratio of the amount of drug that is found during analysis in each filtrate to the amount known (or claimed) to be present in the tested solution, and expressed as a percentage. Recovery of each drug upon filtration (i.e., % LC to centrifuged) is calculated as a ratio of the amount that is found during analysis in each filtrate to the amount that is found in the centrifuged sample, and expressed as a percentage.

For the chosen well-characterized pharmaceutical products, the value of the % LC is between 98-102% for the accurately performed testing procedure. Any additional handling of the samples (e.g. filtering or centrifugation) is a source of additional error or inaccuracy. Therefore, specifications for the filtered samples are set to meet wider 97-103% interval of acceptability. This criterion is set based on the assumption that handling of the filtering process should not add more than 1% error to the sample analysis regardless of the individual filter compatibility.

This assumption was validated in the filter study. The data spread [% relative standard deviation (RSD)], which is caused solely by filtration, is less than 1% for all filters (Table 4). Therefore, results outside the 97-103% interval are indicating OOS results and signaling potential filter incompatibility. Each OOS result is addressed individually in the discussion section of this report.

Drugs in easily soluble salt form are less adsorbed by a generally hydrophobic filter membrane and more likely to stay in solution than be attracted to a membrane. When the amount of organic component is high enough to suppress ionization (and hence solubility) of such compound, it might result in precipitation. Therefore, ranitidine hydrochloride adsorption is studied in aqueous solutions with a low amount of organic component to study pure adsorption effect rather than solid particle retention.

Ibuprofen and two binary mixtures with high and low acetonitrile content are chosen to demonstrate binding of a non-polar drug in the free form to a filter membrane in different media.



Filter Evaluation is Conducted Using the Following Methodology

The flush volume required for consistent sample analysis (flush study) is determined in three steps. In step one, centrifuged samples of each drug are prepared in duplicate and analyzed in duplicate for average percent recovery of the active compound against the label claim. All testing follows USP methodology. Average results can be found in Tables 4-6.

In step two, 20 mL of the sample solution are run through each filter. The 1st, 2nd, 3rd, 5th, 10th, 15th and 20th 1 mL aliquots are collected and analyzed. The drug concentration is measured after filtration. Duplicate HPLC injections of the seven 1 mL aliquots are performed for each filter, with each drug evaluated (280 samples total). The flush volume evaluation from step two is determined as sufficient when the recovery value for the filtered sample is within 97-103% of the centrifuged sample.

In step three, filtered aliquots (from step two) are compared with centrifuged samples (from step one). The recovery of each drug preparation is determined as a percentage of label claim and as a ratio of percentage of label claim to the centrifuged sample, according to USP methodologies. The average recovery of each drug with each filter is given in Tables 4-6.

The chromatographic conditions and standards are given below and in Table 4.

Instrumentation

1. Waters HPLC 1525 with Waters 2487 UV Detector
2. HPLC columns (as directed in each applied USP method)
3. General laboratory equipment and Class A analytical glassware

Table 4

Amount of API expressed as percentage of label claim in centrifuged samples (%LCC) and in samples filtered with Acrodisc PSF Gx_F/0.45 μm GHP (%LCF). The difference in the magnitude in recovery of each drug following filtration or centrifugation is shown as %LCΔFC. API concentrations were determined by HPLC analysis with UV detection at 243 nm for Acetaminophen, 254 nm for Ibuprofen, 230 nm for Ranitidine HCl, 254 nm for Loratadine, 305 nm for Omeprazole, and 206 nm for Clotrimazole according to USP methods.

Table 4

Fraction Collected	Acetaminophen Tylenol		Ibuprofen Motrin		Diphenhydramine HCl Benadryl		Ranitidine Zantac		Loratadine Claritin		Omeprazole Prilosec		Clotrimazole Lotrimin	
	% LC _F	% LC _{ΔFC}	% LC _F	% LC _{ΔFC}	% LC _F	% LC _{ΔFC}	% LC _F	% LC _{ΔFC}	% LC _F	% LC _{ΔFC}	% LC _F	% LC _{ΔFC}	% LC _F	% LC _{ΔFC}
% LC _C	101.3		101.2		101.6		99.0		96.0		99.6		100.8	
1st mL	101.3	0.1	101.4	0.2	64.4	-36.6	99.1	0.1	95.6	-0.4	99.9	0.2	101.1	0.3
2st mL	100.7	-0.6	101.2	0.0	101.4	-0.1	99.3	0.2	97.3	1.4	99.9	0.1	101.1	0.3
3rd mL	100.8	-0.4	101.7	0.5	101.0	-0.6	99.3	0.3	97.6	1.7	99.9	0.2	101.1	0.3
5th mL	101.0	-0.3	101.6	0.4	99.9	-1.6	99.2	0.2	98.2	2.3	99.9	0.2	101.1	0.2
10th mL	101.0	-0.2	101.4	0.2	101.8	0.2	99.1	0.1	97.8	1.9	99.9	0.3	100.7	-0.1
15th mL	100.5	-0.8	101.8	0.6	100.9	-0.6	99.2	0.2	98.0	2.1	100.2	0.6	102.2	1.4
20th mL	100.3	-0.5	101.0	-0.1	101.7	0.1	99.1	0.1	98.1	2.3	100.0	0.4	102.6	1.7

Table 5

Amount of API expressed as percentage of label claim in centrifuged samples (%LCC) and in samples filtered with Acrodisc One syringe filter Gx_F/0.45 μm wwPTFE (%LCF). The difference in the magnitude in recovery of each drug following filtration or centrifugation is shown as %LCΔFC. API concentrations were determined by HPLC analysis with UV detection at 243 nm for Acetaminophen, 254 nm for Ibuprofen, 230 nm for Ranitidine HCl, 254 nm for Loratadine, 305 nm for Omeprazole, and 206 nm for Clotrimazole according to USP methods.

Table 5

Fraction Collected	Acetaminophen Tylenol		Ibuprofen Motrin		Diphenhydramine HCl Benadryl		Ranitidine Zantac		Loratadine Claritin		Omeprazole Prilosec		Clotrimazole Lotrimin	
	% LC _F	% LC _{ΔFC}	% LC _F	% LC _{ΔFC}	% LC _F	% LC _{ΔFC}	% LC _F	% LC _{ΔFC}	% LC _F	% LC _{ΔFC}	% LC _F	% LC _{ΔFC}	% LC _F	% LC _{ΔFC}
% LC _C	101.3		101.2		101.6		99.0		96.0		99.6		100.8	
1st mL	100.7	0.5	101.2	0.0	93.2	-8.3	99.4	0.3	99.5	3.7	100.5	0.9	100.3	-0.5
2st mL	100.2	-1.1	101.2	0.0	100.8	-0.7	99.3	0.3	99.1	3.2	100.5	0.9	100.2	-0.6
3rd mL	101.6	0.3	101.5	0.4	101.2	-0.3	99.3	0.3	99.7	3.9	100.3	0.7	100.3	-0.5
5th mL	99.9	-1.3	101.4	0.3	100.9	-0.7	99.3	0.3	99.0	3.2	100.4	0.8	100.2	-0.6
10th mL	100.2	-1.0	101.1	-0.1	100.7	-0.9	99.3	0.3	99.0	3.2	100.4	0.8	100.1	-0.7
15th mL	100.8	-0.4	101.6	0.4	99.4	-2.1	99.1	0.1	98.1	2.2	100.4	0.8	99.8	-1.0
20th mL	100.5	-0.7	101.3	0.1	100.7	-0.9	99.0	0.0	98.1	2.2	100.3	0.7	100.9	0.1

Table 6

Amount of API expressed as percentage of label claim in centrifuged samples (%LCC) and in samples filtered with Acrodisc syringe filter 0.45 µm wwPTFE (%LCF). The difference in the magnitude in recovery of each drug following filtration or centrifugation is shown as %LC Δ FC. API concentrations were determined by HPLC analysis with UV detection at 243 nm for Acetaminophen, 254 nm for Ibuprofen, 230 nm for Ranitidine HCl, 254 nm for Loratadine, 305 nm for Omeprazole, and 206 nm for Clotrimazole according to USP methods.

Table 6

Fraction Collected	Acetaminophen Tylenol		Ibuprofen Motrin		Diphenhydramine HCl Benadryl		Ranitidine Zantac		Loratadine Claritin		Omeprazole Prilosec		Clotrimazole Lotrimin	
	% LC _F	% LC Δ FC	% LC _F	% LC Δ FC	% LC _F	% LC Δ FC	% LC _F	% LC Δ FC	% LC _F	% LC Δ FC	% LC _F	% LC Δ FC	% LC _F	% LC Δ FC
% LC _C	101.3		101.2		101.6		99.0		96.0		99.6		100.8	
1st mL	100.4	-0.8	101.2	-0.2	102.2	0.6	99.5	0.4	98.0	2.1	99.7	0.1	101.0	0.2
2st mL	100.5	-0.8	100.9	-0.4	101.7	0.2	99.2	0.2	97.7	1.9	99.7	0.1	101.7	0.9
3rd mL	100.6	-0.6	100.7	0.1	101.8	0.3	99.2	0.1	97.9	2.1	99.7	0.1	100.9	0.1
5th mL	100.7	-0.5	100.8	-0.4	102.0	0.4	99.2	0.2	97.9	2.0	99.7	0.1	101.0	0.2
10th mL	100.9	-0.4	100.9	-0.2	102.0	0.4	99.1	0.1	97.4	1.4	99.7	0.1	101.1	0.3
15th mL	101.0	-0.3	101.2	0.1	102.0	0.4	99.3	0.3	98.1	2.2	100.0	0.4	100.5	-0.3
20th mL	101.1	-0.1	101.0	-0.2	102.0	0.4	99.2	0.2	98.0	2.2	99.9	0.3	100.3	-0.5

Discussion

Both tested filter types perform comparably for the tested drugs. In this study, the adsorption of an active ingredient on a filter is evaluated in successive aliquots of filtrate and compared to centrifuged samples. These experiments reveal feasibility of the applied methodology and allowed for determination of the filtration conditions with the least risk of handling error. Subsequently, filter performance is compared in conditions resembling routine finished product analysis at the preferred handling conditions.

Unlike previous studies showing that a flush volume of up to 3 mL can be required to compensate for OOS results when filtering API, the data obtained using the Acrodisc One syringe filter without a prefilter show no such requirement for any of the drugs tested. The Acrodisc One syringe filter with GxF prefilter required a 1 mL flush for only one of the tested drugs, diphenhydramine. Each aliquot tested, from the first to the twentieth milliliter of sample was within specification. The ultra-low binding nature of the wwPTFE membrane used in the Acrodisc One syringe filter simplifies testing procedures and methods. Since there is no longer a requirement for an initial flush volume when using the Acrodisc One syringe filter, the analyst can be comfortable knowing that there is no loss of API due to binding even across a wide variety of drug types and chromatographic requirements. The results confirm that filtration does not affect the finished drug product assay numerically and all tested filters are suitable for achieving 97-103% accuracy with the data spread (precision) less than 1%.

Conclusion

It is accepted that membrane and drug chemistry can affect the amount of adsorption of drug products in a negative manner. If the filter membrane adsorbs too much API, the results may be OOS. Choosing and using filters correctly (to reduce the amount of adsorption) is critical for accurate HPLC in dissolution testing. This investigation demonstrates that Acrodisc One syringe filters with wwPTFE membrane, with and without glass prefilter layers have acceptable drug binding performance in a wide variety of API structures and chemistries.

Acrodisc One syringe filters with wwPTFE membrane, with and without glass prefilter layers have acceptable drugbinding performance.

Features and Benefits for Pall's Products

Title?

Feature	Benefit
Pall is a cGMP compliant facility and ISO 9001 certified.	Superior quality systems in place to ensure highest quality products consistently.
Acrodisc PSF syringe filters are available with single-layer or built-in multi-layered glass fiber prefilter.	Easier filtration of difficult-to-filter solutions.
Acrodisc PSF filters are designed for automation and are Automation Certified. Packaged with AutoPack™ packaging.	Provides reliable and consistent performance in automated applications. Filters can be placed directly on the workstations.
Acrodisc filters are designed for high operating pressures with an integral membrane seal.	Assures high retention efficiency and housing will not burst during use within recommended operating specifications.
Acrodisc filters offer better retention efficiency.	Longer HPLC column life. Less HPLC maintenance. Less chromatographic interference.
Available with HPLC certification or IC certification.	More consistent chromatography with less extractable interference.
Pall Corporation is the largest membrane manufacturer in the world.	We maintain control over membrane manufacturing to assure consistent membrane with the highest quality at all times. We have material combinations to find a solution for every customer's needs.
Pall sells products into all aspects of the drug development pipeline from discovery to delivery.	We fully understand customers' needs and requirements, and share that knowledge across divisions. We are regularly audited by the FDA and large pharmaceutical and biotechnology companies, with no "483's" in over ten years of successful audits.

Product Specifications

Materials of Construction

HPLC and IC Certified Syringe Filters

Housing

Pure Polypropylene

Media

Nylon: hydrophilic nylon

PVDF: hydrophilic polyvinylidene fluoride

PTFE: hydrophobic polytetrafluoroethylene

wwPTFE: water wettable hydrophilic polytetrafluoroethylene IC: Supor, hydrophilic polyethersulfone

Glass Fiber: hydrophilic borosilicate glass fiber

Fittings

Female luer lock inlet, standard make luer or minispike outlets

Mass Spectrometry Certified Syringe Filters

Housing

High Density Polyethylene

Media

WWPTFE hydrophilic polytetrafluoroethylene

Fittings

Female luer lock inlet, standard make luer or minispike outlets



Specifications

Fisher Scientific Part No.	Pall Part No.	Description	Pore Size	Typical Hold-Up Volume (w/air purge)	Maximum Operating Temperature	Maximum Operating Pressure	Typical Water Flow Rate
17144681 17164681	AP-4523 AP-4529	GxF/Glass	1 µm	< 125 µL	82 °C (180 °F) at 2.1 bar (210 kPa, 30 psi)	4.1 bar (410 kPa, 60 psi) at 21-24 °C (70-75 °F)	795 mL/min at 1.0 bar (100 kPa, 15 psi)
17134691 17144691	AP-4787 AP-4788	GxF/Nylon	0.2 µm	< 150 µL	55 °C (131 °F) at 2.1 bar (210 kPa, 30 psi)	4.1 bar (410 kPa, 60 psi) at 21-24 °C (70-75 °F)	115 mL/min at 2.1 bar (210 kPa, 30 psi)
17174681 17184681 17154681	AP-4548 AP-4549 AP-4528	GxF/Nylon	0.45 µm	< 150 µL	55 °C (131 °F) at 2.1 bar (210 kPa, 30 psi)	4.1 bar (410 kPa, 60 psi) at 21-24 °C (70-75 °F)	215 mL/min at 2.1 bar (210 kPa, 30 psi)
17154691 17164691	AP-4790 AP-4791	GxF/PTFE	0.2 µm	< 125 µL	100 °C (212 °F) at 2.1 bar (210 kPa, 30 psi)	4.1 bar (410 kPa, 60 psi) at 21-24 °C (70-75 °F)	NA
17184661 17104671 17194661	AP-4301 AP-4303 AP-4302	GxF/PTFE	0.45 µm	< 125 µL	100 °C (212 °F) at 2.1 bar (210 kPa, 30 psi)	4.1 bar (410 kPa, 60 psi) at 21-24 °C (70-75 °F)	395 mL/min at 1.0 bar (100 kPa, 15 psi) (MeOH)
17174691 17184691 17194691	AP-4792 AP-4793 AP-4794	GxF/PVDF	0.2 µm	< 125 µL	82 °C (180 °F) at 2.1 bar (210 kPa, 30 psi)	4.1 bar (410 kPa, 60 psi) at 21-24 °C (70-75 °F)	95 mL/min at 2.1 bar (210 kPa, 30 psi)
17124671 17134671 17114671	AP-4309 AP-4310 AP-4308	GxF/PVDF	0.45 µm	< 125 µL	82 °C (180 °F) at 2.1 bar (210 kPa, 30 psi)	4.1 bar (410 kPa, 60 psi) at 21-24 °C (70-75 °F)	144 mL/min at 2.1 bar (210 kPa, 30 psi)
17124701	AP-4799	GxF/Supor	0.2 µm	≤ 200 µL	100 °C (212 °F) at 2.1 bar (210 kPa, 30 psi)	4.1 bar (410 kPa, 60 psi) at 21-24 °C (70-75 °F)	190 mL/min at 2.1 bar (210 kPa, 30 psi)
17154671 17164671	AP-4425 AP-4426	GxF/Supor	0.45 µm	≤ 200 µL	100 °C (212 °F) at 2.1 bar (210 kPa, 30 psi)	4.1 bar (410 kPa, 60 psi) at 21-24 °C (70-75 °F)	360 mL/min at 2.1 bar (210 kPa, 30 psi)
17174701 17184701 17194701	AP-4913 AP-4914 AP-4915	GxF/wwPTFE	0.2 µm	≤ 220 µL	55 °C (131 °F) at 2.1 bar 4.1 bar (410 kPa, 60 psi)	6.2 bar (620 kPa, 90 psi) at 21-24 °C (70-75 °F)	112 mL/min at 2.06 bar (30 psi)
17134711 17144711 17154711	AP-4919 AP-4920 AP-4921	GxF/wwPTFE	0.45 µm	≤ 220 µL	55 °C (131 °F) at 2.1 bar 4.1 bar (410 kPa, 60 psi)	6.2 bar (620 kPa, 90 psi) at 21-24 °C (70-75 °F)	112 mL/min at 2.06 bar (30 psi)
17104691 17114691	AP-4585 AP-4785	IC (PES)	0.45 µm	< 125 µL	100 °C (212 °F) at 2.1 bar (210 kPa, 30 psi)	4.1 bar (410 kPa, 60 psi) at 21-24 °C (70-75 °F)	420 mL/min at 2.1 bar (210 kPa, 30 psi)
17174671 17134681	AP-4436 AP-4522	Nylon	0.2 µm	< 125 µL	55 °C (131 °F) at 2.1 bar (210 kPa, 30 psi)	4.1 bar (410 kPa, 60 psi) at 21-24 °C (70-75 °F)	115 mL/min at 2.1 bar (210 kPa, 30 psi)
17184671 17114681	AP-4438 AP-4502	Nylon	0.45 µm	< 125 µL	55 °C (131 °F) at 2.1 bar (210 kPa, 30 psi)	4.1 bar (410 kPa, 60 psi) at 21-24 °C (70-75 °F)	245 mL/min at 2.1 bar (210 kPa, 30 psi)

Specifications

Fisher Scientific Part No.	Pall Part No.	Description	Pore Size	Typical Hold-Up Volume (w/air purge)	Maximum Operating Temperature	Maximum Operating Pressure	Typical Water Flow Rate
17174661 17124681	AP-4225 AP-4521	PTFE	0.2 µm	< 125 µL	100 °C (212 °F) at 2.1 bar (210 kPa, 30 psi)	4.1 bar (410 kPa, 60 psi) at 21-24 °C (70-75 °F)	245 mL/min at 1.0 bar (100 kPa, 15 psi) (MeOH)
17164661 17104681	AP-4219 AP-4501	PTFE	0.45 µm	< 125 µL	100 °C (212 °F) at 2.1 bar (210 kPa, 30 psi)	4.1 bar (410 kPa, 60 psi) at 21-24 °C (70-75 °F)	510 mL/min at 1.0 bar (100 kPa, 15 psi) (MeOH)
17104701 17114701	AP-4796 AP-4797	PVDF	0.2 µm	< 100 µL	82 °C (180 °F) at 2.1 bar (210 kPa, 30 psi)	4.1 bar (410 kPa, 60 psi) at 21-24 °C (70-75 °F)	95 mL/min at 2.1 bar (210 kPa, 30 psi)
17144671 17194671	AP-4408 AP-4500	PVDF	0.45 µm	< 100 µL	82 °C (180 °F) at 2.1 bar (210 kPa, 30 psi)	4.1 bar (410 kPa, 60 psi) at 21-24 °C (70-75 °F)	144 mL/min at 2.1 bar (210 kPa, 30 psi)
17154661 17194681	AP-4189 AP-4568	Versapor	0.8 µm	< 125 µL	55 °C (131 °F) at 2.1 bar (210 kPa, 30 psi)	4.1 bar (410 kPa, 60 psi) at 21-24 °C (70-75 °F)	905 mL/min at 3.1 bar (310 kPa, 45 psi)
17134661 17144661	AP-4001 AP-4002	Versapor	10 µm	< 125 µL	82 °C (180 °F) at 2.1 bar (210 kPa, 30 psi)	4.1 bar (410 kPa, 60 psi) at 21-24 °C (70-75 °F)	1182 mL/min at 1.0 bar (100 kPa, 15 psi)
17144701 17154701 17164701	AP-4910 AP-4911 AP-4912	wwPTFE	0.2 µm	< 100 µL	55 °C (131 °F) at 2.1 bar 4.1 bar (410 kPa, 60 psi)	6.2 bar (620 kPa, 90 psi) at 21-24 °C (70-75 °F)	151 mL/min at 2.06 bar (30 psi)
17104711 17114711 17124711	AP-4916 AP-4917 AP-4918	wwPTFE	0.45 µm	< 100 µL	55 °C (131 °F) at 2.1 bar 4.1 bar (410 kPa, 60 psi)	6.2 bar (620 kPa, 90 psi) at 21-24 °C (70-75 °F)	263 mL/min at 2.06 bar (30 psi)



Chemical Compatibility Guide

Solvent	wwPTFE	PTFE	Glass	Versapor	Nylon	IC, Supor (PES)	PVDF
Acetone	R	R	R	NR	R	NR	NR
Acetonitrile	R	R	R	NR	R	R	R
Acetic Acid, glacial	R	R	R	NR	NR	R	R
n-Butanol	R	R	R	R	R	R	R
Chloroform	R	R	R	NR	R	NR	NR
Dimethyl Formamide	R	R	R	NR	R	NR	NR
Dimethyl Sulfoxide	R	R	R	NR	R	NR	R
Ethanol	R	R	R	R	R	R	R
Ethyl Acetate	R	R	R	R	R	NR	R
Ethel Ether	R	R	R	R	R	R	R
Hydrochloric Acid (1N)	R	R	R	•	NR	R	R
Hexane, dry	R	R	R	R	R	LR	R
Methanol	R	R	R	R	R	R	R
Methylene Chloride	R	R	R	NR	R	NR	R
Methyl Ethyl Ketone	R	R	R	NR	R	NR	NR
N-Methyl Pyrrolidone	R	R	R	•	NR	NR	R
Isopropanol	R	R	R	R	R	R	R
Sodium Hydroxide (3N)	R	R	R	R	R	R	NR
Tetrahydrofuran	R	R	R	NR	R	NR	NR
Tetrahydrofuran/water (50/50)	R	R	R	•	R	•	R
Toluene	R	R	R	R	R	R	R
Water	R	R	R	R	R	R	•
Ammonium Hydroxide	R	R	R	•	•	•	•

R = RESISTANT. No significant change was observed in flow rate or bubble point of the membrane.

LR = LIMITED RESISTANCE. Moderate changes in physical properties or dimension of the membrane were observed. The filter may be suitable for short term, non-critical use at room temperature.

NR = NOT RESISTANT. The membrane is basically unstable. In most cases, extensive shrinkage or swelling occurs. The filter may gradually weaken or partially dissolve after extended exposure.

• = Insufficient data. Trial testing is recommended.

Test Methods: The data presented in this chart is a compilation of testing by Pall Corporation with certain chemicals, manufacturer's data, or compatibility recommendations from the Compass Corrosion Guide, by Kenneth M. Pruett. This data is intended to provide expected results when filtration devices are exposed to chemicals under static conditions for 48 hours at 25 °C (77 °F), unless otherwise noted. This chart is intended only as a guide. Accuracy cannot be guaranteed. Users should verify chemical compatibility with a specific filter under actual use conditions. Chemical compatibility with a specific filter, under actual use conditions, is affected by many variables including temperature, pressure, concentration, and purity. Various chemical combinations prevent complete accuracy.

References

- Azopharma Contract Pharmaceutical Services, Filter Evaluation Study Report Number R050T18B, (October 2005) (Internal Pall Report)
- B. Pearce and W.L. Thomas, *Anal. Chem.*, 44, 1107 (1972).
- D. Parriott, *A Practical Guide to HPLC Detection* (Academic Press Inc, 1993).
- Dressman B., Lindenberg M., Wiegand C., Comparison of the Adsorption of Several Drugs to Typical Filter Materials, *Dissolution Technologies*, (2005).
- F.M. Rabel, *J. Chromatogr. Sci.*, 18, 222 (1980).
- H. Spaans, H. Terol, and A. Onderwater, *J. Chromatogr. Sci.*, 14, 246 (1976).
- J.A. Dean, *Analytical Chemistry Handbook*, McGraw-Hill, Inc. (1995).
- J.G. Nikelly and D.A. Ventura, *Anal. Chem.*, 51, 1585 (1979).
- J. Merrill, *American Laboratory*, 19 (10), 74 (1987).
- *Jones Chromatography Manual*, Lakewood, CO, (1995).
- J.W. Dolan and L.R. Snyder, *Troubleshooting LC Systems*, Humana Press Clifton, NJ, (1989).
- L.R. Snyder, J.J. Kirkland, and J.L. Glajch, *Practical HPLC Method Development*, 2nd Edition, John Wiley & Sons, Inc. (1997).
- L.V. Berry and B.L. Karger, *Anal. Chem.*, 45, 819A (1973).
- R.W. Yost, L.S. Ettre, and R.D. Conlon, *Practical Liquid Chromatography. An Introduction*, Perkin-Elmer, Norwalk, (1980).
- W.W. Yau, J.J. Kirkland, and D.D. Bly, *Modern Size-Exclusion Liquid Chromatography*, Wiley, New York, (1979).
- M. Lindenberg, C. Wiegand, B. Dressman, Comparison of the Adsorption of Several Drugs to Typical Filter Materials, *Dissolution Technologies*, (2005).
- M.L. Mayer, *LCGC*. 14 (10), 902 (1996).
- M.L. Mayer, *American Laboratory*, 29 (1), 1 (1997).
- M. Martin, G. Blu, C. Eon, and G. Guiochon, *J. Chromatogr. Sci.*, 112, 399 (1975).
- P. Achener, S.R. Abbott, and R.L. Stevenson, *J. Chromatogr. Sci.*, 130, 29 (1977).
- R.E. Jentoft and T.H. Gouw, *J. Chromatogr. Sci.*, 14, 246 (1976).
- R.E. Majors, *LCGC*. 13 (5), 364 (1995).
- R.M. Cassidy and R.W. Frei, *Anal. Chem.*, 44, 2250 (1972).
- USP 28 – NF 23, page 1702, 1704 (Ranitidine Hydrochloride Monograph). *Pharmacopeial Forum: Volume Number 30(6)*, page 2033.
- USP 28 – NF 23, page 1770, 1771 (Simvastatin Monograph). *Pharmacopeial Forum: Volume Number 30(5)*, page 1647. *Pharmacopeial Forum: Volume Number 29(2)*, page 437.
- *The Waters Chromatography Handbook*, Milford, MA (1993-1994).
- T.W. Smuts, D.J. Solms, F.A. Van Niekerk, and V. Petorius, *J. Chromatogr. Sci.*, 7, 24 (1969).
- USP 28 – NF 23, page 16, 17, 19 (Acetaminophen Monograph). *Pharmacopeial Forum: Volume Number 27(3)*, page 2494, 2495.
- USP 28 – NF 23, page 991, 993 (Ibuprofen Monograph). *Pharmacopeial Forum: Volume Number 27(4)*, page 2740.
- USP 28 – NF 23, page 1149, 1151 (Loratadine Monograph) USP 28 – NF 23 Supplement: No. 2, page 3500.
- *Pharmacopeial Forum: Volume Number 30(6)*, page 2011. *Pharmacopeial Forum: Volume Number 29(4)*, page 1045.
- V.R. Meyer, 2nd Edition, *Practical HPLC*, John Wiley and Sons LTD, (1994).

Distributed by Fisher Scientific. Contact us today:

Austria: fishersci.at **Belgium:** fishersci.be **Denmark:** fishersci.dk
Germany: fishersci.de **Ireland:** fishersci.ie **Italy:** fishersci.it
Finland: fishersci.fi **France:** fishersci.fr **Netherlands:** fishersci.nl
Norway: fishersci.no **Portugal:** fishersci.pt **Spain:** fishersci.es
Sweden: fishersci.se **Switzerland:** fishersci.ch **UK:** fishersci.co.uk

© 2021 Thermo Fisher Scientific Inc. All rights reserved.

Trademarks used are owned as indicated at fishersci.com/trademarks.

